

## E. Z. STEER - VOLVO I/PRE 1989

Full kit consists of:

- 1 - 40010 complete bracket assembly
  - 40100 main bracket body only
  - 20200 quick connector
  - 80020 stainless steel bands
- 1 - 10002 standard rod 23" - 36"
- 1 - 50020 small O.B. bracket assembly - 3"
  - 50200 main bracket/3" pin
  - 20200 quick connector
  - 80020 stainless steel bands

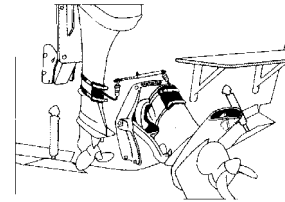

EZS40002 VOLVO I - PRE 89 .....\$ 329.95

## E. Z. STEER - VOLVO II

Full kit consists of:

- 1 - 40210 complete bracket assembly
  - 42100 main bracket body only
  - 20200 quick connector
  - 80020 stainless steel bands
- 1 - 10002 standard rod 23" - 36"
- 1 - 50020 small O.B. bracket assembly - 3"
  - 50200 main bracket/3" pin
  - 20200 quick connector
  - 80020 stainless steel bands

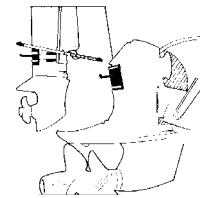

EZS42002 VOLVO II .....\$ 329.95

## E.Z. STEER - OUTBOARD TO OUTBOARD

Full kit consists of:

- 1 - 60010 complete bracket assembly
  - 60100 main bracket body only
  - 20200 quick disconnect
  - 80020 stainless steel bands
- 1 - Rod assembly (length varies)
  - 10001 short rod assembly
  - 10002 standard rod assembly
  - 10004 medium rod assembly
  - 10003 long rod assembly
- 1 - 50010 small O.B. bracket assembly 4"
  - 50100 main bracket with 4" pin
  - 20020 quick connector
  - 80020 stainless steel bands

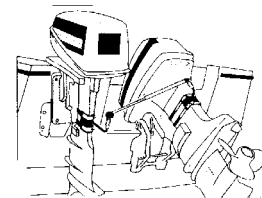

EZS60001 SHORT 19" TO 29" .....\$ 329.95  
 EZS60002 STANDARD 23" TO 36" .....\$ 329.95  
 EZS60003 LONG 29" TO 50" .....\$ 329.95  
 EZS60004 MEDIUM 27" TO 48" .....\$ 329.95

## E. Z. STEER - BERKELEY JET

Full kit consists of:

- 1 - 75010 complete bracket assembly
  - 75100 main bracket body only
  - 20200 quick connector
  - 75110 bracket back plate
  - 75400 bracket hardware ( 2 SS bolts and 2 SS lockwashers)
- 1 - 10002 standard rod 23" - 36"
- 1 - 50010 small O.B. bracket assembly - 4"
  - 50100 main bracket/4" pin
  - 20200 quick connector
  - 80020 stainless steel bands

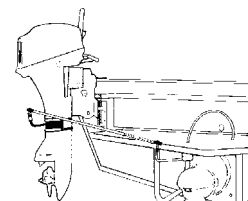

EZS75002 BERKELEY JET .....\$ 329.95

## E. Z. STEER - OMC

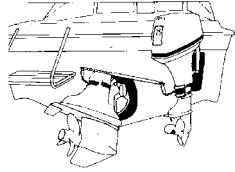

Full kit consists of:

- 1 - 20010 complete bracket assembly
  - 20100 main bracket body only/3"
  - 20200 quick connector
  - 20300 edge clamp
  - 20400 main bracket hardware ( 2 SS screws, 2 nuts, 2 washers)
- 1 - 10002 standard rod 23" - 36"
- 1 - 50010 small O.B. bracket assembly - 4"
  - 50100 main bracket/4" pin
  - 20200 quick connector
  - 80020 stainless steel bands

EZS20002 OMC .....\$ 329.95

## E. Z. STEER - OMC COBRA

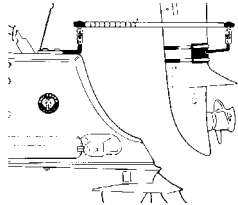

Full kit consists of:

- 1 - 22010 complete bracket assembly
  - 22100 main bracket body only/4" pin
  - 20200 quick connector
  - 22400 main bracket hardware (2 long studs, 2 short studs, 4 hex nuts, 4 nylok nuts, 4 lock washers, 8 flat washers, all stainless steel hardware.
- 1 - 10002 standard rod 23" - 36"
- 1 - 50010 small O.B. bracket assembly - 4"
  - 50100 main bracket/4" pin
  - 20200 quick connector
  - 80020 stainless steel bands

EZS22002 OMC COBRA .....\$ 329.95

## E. Z. STEER - MERCUISER ALPHA I

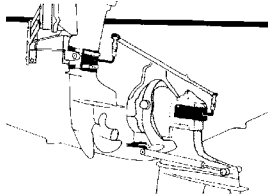

Full kit consists of:

- 1 - 30010 complete bracket assembly
  - 30100 main bracket body only/2" pin
  - 20200 quick connector
- 1 - 10002 standard rod 23" - 36"
- 1 - 50010 small O.B. bracket assembly - 4"
  - 50100 main bracket/4" pin
  - 20200 quick connector
  - 80020 stainless steel bands

EZS30002 MERCUISER ALPHA I .....\$ 329.95

## E. Z. STEER - MERCUISER ALPHA I - 2ND GENERATION

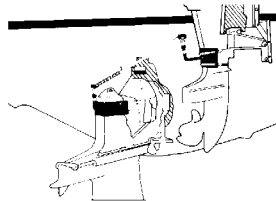

Full kit consists of:

- 1 - 37010 complete bracket assembly
  - 30100 main bracket body only/2" pin
  - 20200 quick connector
- 1 - 10002 standard rod 23" - 36"
- 1 - 50010 small O.B. bracket assembly - 4"
  - 50100 main bracket/4" pin
  - 20200 quick connector
  - 80020 stainless steel bands

EZS37002 MERCUISER ALPHA I -2ND GEN .....\$ 329.95

## E. Z. STEER - MERCUISER BRAVO

Full kit consists of:

- 1 - 35011 complete bracket assembly
  - 35100 bracket
  - 35150 bracket with quick connector
  - 20200 quick connector
  - 35300 adapter clip assembly
  - 35350 left clip
  - 35360 right clip
  - hardware #5
- 1 - 10002 standard rod 23" - 36"
- 1 - 50010 small O.B. bracket assembly - 4"
  - 50100 bracket
  - 50150 bracket with quick connector
  - 20200 quick connector
  - 80020 stainless steel bands (pr.)
  - 80520 band sleeves (pr.)
  - 50110 small bracket liner

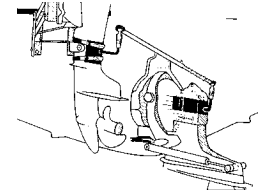

EZS35002            MERCUISER BRAVO .....\$ 329.95

## E. Z. STEER INDIVIDUAL PARTS LIST

EZS10001	SHORT ROD .....	\$ 165.95
EZS10002	STANDARD ROD .....	\$ 165.95
EZS10003	LONG ROD .....	\$ 165.95
EZS10004	ARIMA ROD .....	\$ 165.95
EZS10005	EXTRA LONG ROD .....	\$ 165.95
EZS10300	OUTER TUBE BALL JOINT .....	\$ 30.95
EZS10400	INNER TUBE BALL JOINT .....	\$ 30.95
EZS13200	QUICK CONNECTOR .....	\$ 21.95
EZS22010	COBRA BRACKET .....	\$ 73.95
EZS30010	MERC I/O BRACKET .....	\$ 70.95
EZS37010	MERCUISER GEN II BRACKET .....	\$ 82.95
EZS44002	VOLVO SX COBRA .....	\$ 329.95
EZS44010	COMPLETE BRACKET ASSEMBLY .....	\$ 87.95
EZS50010	SMALL O/B BRACKET COMPLETE .....	\$ 79.95
EZS50150	AUXILARY BRACKET ASSEMBLY W/QC 4" .....	\$ 44.95
EZS60010	LARGE O/B BRACKET COMPLETE .....	\$ 75.95
EZS75010	BERKELEY BRACKET .....	\$ 77.95
EZS18020	LARGE STAINLESS BANDS .....	\$ 31.95
EZS18030	EXTRA LONG BANDS 20" STAINLESS .....	\$ 14.95

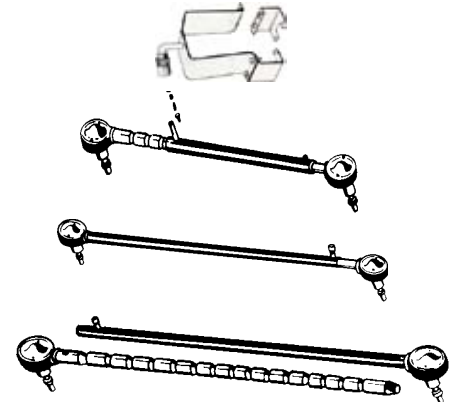

## PANTHER T4 ELECTRO-STEER AUXILIARY STEERING

24' cable allows you to steer your kicker motor from anywhere in the boat. Mounts to your kicker motor in minutes. Does not take up any space on your transom.

PAN55-0102	T4 FRESH WATER ELECTRO-STEER .....	\$ 484.95	D
PAN55-0103	T4 SALTWATER ELECTRO-STEER .....	\$ 496.95	D



## PANTHER ELECTROSTEER WIRELESS REMOTE

200 Ft Range. Operates on 12v Battery. Universal Design. For "all" 2 bullet molded connectors. Adapted for "all" Panther Steering and Trim & Tilt units. Lanyard included.

PAN55-0105	ELECTROSTEER WIRELESS REMOTE .....	\$ 176.95	D
------------	------------------------------------	-----------	---



PANTHER

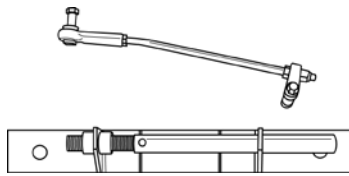

## T & R MARINE MECHANICAL STEERING ATTACHMENT KIT

For use when obstructions prevent thru-tube installation. Fits over mounting bolts. Aluminum brackets and plated steel hardware. Johnson and Evinrude to 140 H.P.

TNR-FWK3470 STEERING KIT .....\$ 179.95

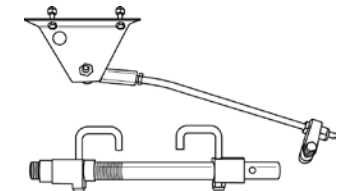

## T & R CLAMP BRACKET ATTACHMENT KIT/J BOLT TYPE

These kits mount on the engine clamp bracket to provide thru tube steering. Aluminum brackets and plated steel hardware. 60-140 H.P. Chrysler/Force.

TNR-FWK3476 STEERING KIT .....\$ 140.95

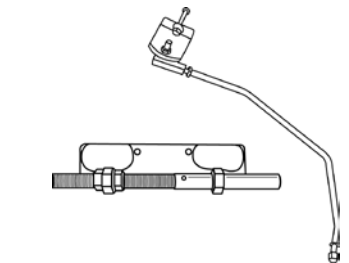

## T & R UNIVERSAL SMALL BOAT/SMALL ENGINE CLAMP BRACKET ATTACHMENT KIT

This kit fits under engine clamps and is designed to prevent motor from jumping off transom. Also prevents damage to the transom by the clamps. Aluminum and plated steel. Fits the following applications:

- Mariner 9.9 - 15HP 1982 and newer
- Suzuki 9.9 - 15 - 16 - 25HP 1982 and newer
- Johnson/Evinrude 9.9 - 15 - 25 - 30 - 35 - 40HP 1977 and newer
- Yamaha 9.9 - 15HP 1984 and newer

TNR-FWK3475 SMALL STEERING KIT .....\$ 145.95



## T & R HEAVY DUTY DRAG LINK CONNECTOR ARMS

3/8" diameter plated steel for Johnson, Evinrude, Yamaha and Tohatsu up to 120 HP.

TNR-SLA940F DRAG LINK .....\$ 54.95

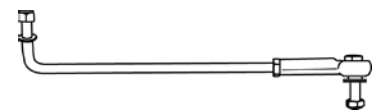

## T & R HEAVY DUTY DRAG LINK CONNECTOR ARMS

3/8" diameter plated steel for Mercury and Mariner up to 120 HP.

TNR-SLA950F DRAG LINK .....\$ 60.95



## T & R SUPER DUTY DRAG LINK CONNECTOR ARMS

7/16" diameter plated steel for cables with 3/8" hole only. 7/16" thread and cable end eyelet connector assembly. For Johnson, Evinrude and Yamaha engines 120HP to 235HP.

TNR-SLA945F DRAG LINK .....\$ 90.95



## T & R SUPER DUTY DRAG LINK CONNECTOR ARMS

7/16" diameter plated steel for cables with 3/8" hole only. 7/16" thread and cable end eyelet connector assembly. For Mercury and Mariner engines 120HP to 200HP.

TNR-SLA955F DRAG LINK .....\$ 73.95

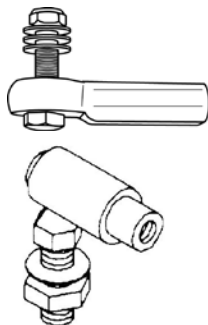

## T & R PLATED STEEL BALL JOINTS

TNR-FBJ9003 1/2" - 20 THREAD .....\$ 32.25  
 TNR-FBJ9004 3/8" - 24 THREAD .....\$ 29.25

## TELEFLEX 4300 SERIES BALL JOINT

TEL-CA28014P 4300 SERIES BALL JOINT 1/4" 28 .....\$ 23.49

## STEARNS AUXILIARY MOTOR STEERING KIT

Connects trolling motor to main engine. Easy to install, easy to remove.

STE-G819	ZINC PLATED STEEL STEERING KIT.....	\$ 26.45
STE-G820	STAINLESS STEEL STEERING KIT.....	\$ 61.95
STE-G821	HYDRAULIC STEERING ADAPTER KIT.....	\$ 13.99

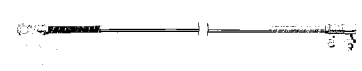

## PANTHER AUXILIARY STEERING KIT

An auxiliary motor steering kit is the ideal way to provide remote control steering for any type or size of outboard trolling motor up to 25 horse-power.

PAN55-2400	ZINC AUX STEERING KIT .....	\$ 37.95
PAN55-2600	STAINLESS STEEL AUX STEERING KIT.....	\$ 79.95



## STEARNS CONNECTOR RODS

Heavy duty 3/8" with long threaded ends for cut to exact length.

STE-G826	24" - ZINC PLATED.....	\$ 7.09
STE-G827	24" - STAINLESS STEEL.....	\$ 18.59



## STEARNS QUICK DISCONNECT ASSEMBLY

Designed for trolling motor steering connectors. Spring action release. Ball stud is 3/8" - 24 thread x 7/8"L. The body is tapped for 3/8" - 24 threaded rod.

STE-G824	ZINC PLATED BULK.....	\$ 7.19
STE-G822	ZINC PLATED 2 PACK.....	\$ 13.99
STE-G823	STAINLESS STEEL 2 PACK.....	\$ 37.45

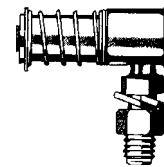

## PERKO CHROME/ZINC TILLER ROPE GUIDES

PK01256-DP-CHR	5/16" ID- 1-1/4" L X 3/4" W.....	\$ 7.99
----------------	----------------------------------	---------



PERKO

## PERKO TILLER ROPE GUIDES

Chrome plated zinc with white plastic sheave. Max rope size 1/4". OD 7/8". 2" x 3/4" base. Screw size #8.

PK01243-DP-CHR	TILLER ROPE GUIDE.....	\$ 10.79
----------------	------------------------	----------



PERKO

## SEA-DOG CABLE CLAMP

SEA091852-1	3/16" CABLE DIA.....	\$ 3.35
-------------	----------------------	---------



SEADOG

## PERKO CHROME PLATED TILLER ROPE CLAMP

PK01226-DP-CHR	1/8" OR 3/16" WIRE - PR.....	\$ 7.79
----------------	------------------------------	---------



PERKO

## PERKO TILLER ROPE PULLEY

Stainless steel with white plastic sheave. Swivel type with strap. Max rope size 1/4". 2-5/16" O.D. sheave. 3-3/4" L. 1-5/8" strap. 2 per bag.

PK0565-DP	ROPE PULLEY.....	\$ 22.99
-----------	------------------	----------



PERKO

## PERKO TILLER ROPE PULLEY

Stainless steel with white plastic sheave. Swivel snap hook type. Max rope size 1/4". 2-5/16" O.D. sheave. 4-5/8" L. 1/2" strap throat. 2 per bag.

PK0634-DP	ROPE PULLEY.....	\$ 32.99
-----------	------------------	----------



PERKO



## T & R STEERING TUBE CLEANING BRUSH

Cleans all corroded engine tilt tubes. Steel wire with 8" shaft. For use with electric motor drill.

TNR-TB10 CLEANING BRUSH.....\$ 22.25



## T & R STEERING CABLE BOOT

Protects against cable freeze-up, rust and corrosion. Keeps cable lubricated. Fits most domestic and foreign outboard and IO's.

TNR-SB34 CABLE BOOT.....\$ 16.75

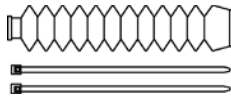

## SEA-DOG RUBBER STEERING CABLE BOOT

SEA521700 8" L X 1" & 3/8" OPENINGS.....\$ 7.50

SEA-DOG

## SEA-DOG RUBBER MOTORWELL BOOTS

SEA521630 3" D X 3/16" OPENING.....\$ 1.95

SEA521655 5-1/2" D X 9/16" OPENING.....\$ 7.75

SEA-DOG



## T-H CABLE BOOTS

These cable boots provide a fully open area to pass wiring and cables through. When rigging is complete, the cable tie is used to snug up the boot around wiring and cables.

TNH-CB1DP 3" BLACK.....\$ 6.19

TNH-CB4DP 4-1/2" BLACK.....\$ 8.59

T-H Marine

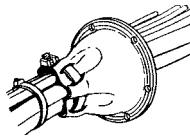

## T-H MARINE BULKHEAD PASS THRU

Watertight seal for cables, Tubing or wires. Self-attaching no hardware needed. Turn down washer included. Fits 3/4" hole. Slot is 1/4" dia.

TNH-THCC1-DP BLACK BULKHEAD PASS THRU.....\$ 10.19

TNH-THCC2-DP WHITE BULKHEAD PASS THRU.....\$ 10.19

T-H Marine

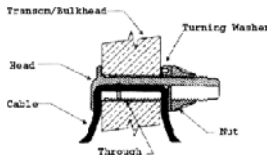

## T-H FLEX SLEEVING

Lightweight jacketing for bundling and protecting wires, cables and hoses. Braided from high temperature yarns, T-H Flex offers total protection for wire and cable assemblies. The unique expansion characteristics make T-H Flex easy to slip on; expands up to 4-times its normal diameter.

TNH-FLX25 1/4" X 100' SPOOL.....\$ 38.95

TNH-FLX50 1/2" X 100' SPOOL.....\$ 77.95

TNH-FLX75 3/4" X 100' SPOOL.....\$ 104.95

TNH-FLX125 1-1/4" X 50' SPOOL.....\$ 77.95

TNH-FLX150 1-1/2" X 50' SPOOL.....\$ 97.95

T-H Marine

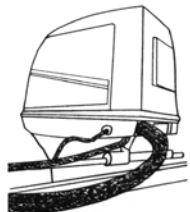

## T-H MARINE RIGGING FLANGE

Completes Professional Rigging Installation. Complies with ABYC - NMMA Specs. Split Design Allows Installation on Pre-Rigged Boats. Fuel Hose Port Fits Type "A" Hose & Hose Union Fits Type "B" Hose. Installs with T-H Marine Rigging Hose.

TNH-RFFHP1 RIGGING FLANGE WITH FUEL PORT.....\$ 14.19

TNH-RF1-DP RIGGING FLANGE.....\$ 16.59

TNH-RFH-1 RIGGING FLANGE HOSE 2" (PER FOOT).....\$ 4.89

TNH-RFHU-1 RIGGING HOSE UNION.....\$ 11.99

T-H Marine



**SEA-DOG HOLE LINER**

injection molded polyethylene.

SEA521600-1      4-1/16" OUTSIDE 2-9/16" INSIDE . . . . . \$    3.40



SEADOGLITE

**DAVIS LUBE II STEERING ROD SEAL**

LUBE II™ allows sticky, hard to move steering rods to be properly and easily lubricated for smooth, easy steering action. This lubricator's unique design keeps moisture and contaminants out while enabling you to pour or pump several types of lubricant in.

DVS425              LUBE II SEERING ROD SEAL . . . . . \$    26.45



DAVIS

**DAVIS CABLE BUDDY STEERING LUBRICATION SYSTEM**

The complete steering cable lubrication system. Includes stainless steel Cable Buddy nut with plug and sealing washer, oiling tube and assembly and 16 oz. Max Lube. Works on inboards, IO's and outboards. Prevents corrosion and freezing to - 40F. Virtually eliminates all wear in the inner cable. Patented.

DVS420              ONE LUBE NUT . . . . . \$    35.95  
DVS421              TWO LUBE NUTS . . . . . \$    46.45

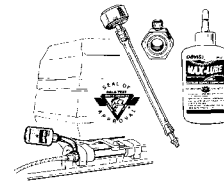

DAVIS

**SEA-DOG DESTROYER WHEEL**

Formed 304 stainless steel. 15-1/8" dia., 3-1/2" hub dia., 6 spokes, 10 degree angle.

SEA230115          15" STAINLESS WHEEL . . . . . \$    89.95



SEADOGLITE

**SEADOG STEERING WHEEL MANEUVERING KNOB**

Investment cast 316 stainless.

SEA230106-1      STEERING WHEEL KNOB . . . . . \$    25.50



SEADOGLITE

**GRANT STEERING WHEEL**

A 3 spoke, 13-1/2" diameter featuring solid welded construction and a textured foam cushion grip rim material for added comfort and control. 2-1/2" finger clearance. Also available as a kit containing a universal 3/4" standard tapered shaft.

GRT33827-1        WHEEL KIT . . . . . \$    67.95 \*  
GRT3627-1        STANDARD 3/4" TAPER HUB . . . . . \$    25.75

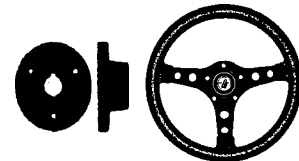

**GRANT FORMULA GT WHEEL**

Formula GT Wheel. Black hand grip with black anodized spokes. 13-1/2" diameter, 2" finger clearance with standard hub to fit 3/4" tapered shaft w/keyway. Includes installation hub and center cap w/o emblem.

GRT160-11        3 SPOKE STRAIGHT CENTER STANDARD HUB . . \$    101.95  
GRT190-11        3 SPOKE ANGLED CENTER STANDARD HUB . . . \$    101.95



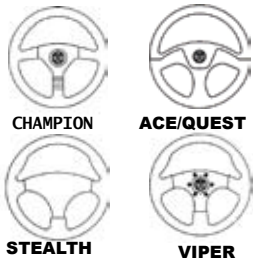

CHAMPION

ACE/QUEST

STEALTH

VIPER



FANTASY

FOLLETTO



## TELEFLEX CHAMPION STEERING WHEEL

Designed for helms with standard 3/4" tapered shafts, Teleflex Steering Wheels are made from high quality, durable parts. Each Teleflex Steering Wheel is easy to mount, and features a tough, attractive design to complete any Steering System.

TEL-SW59291B	13.5" CHAMPION BLACK STEERING WHEEL . . .	\$ 26.69
TEL-SW59691B	13" ACE/QUEST BLACK STEERING WHEEL . . .	\$ 33.69
TEL-SW59401B	14" STEALTH BLACK STEERING WHEEL . . . . .	\$ 41.39
TEL-SW52021P	14" VIPER BLACK STEERING WHEEL . . . . .	\$ 131.99

## UFLEX V32 STEERING WHEEL

Thermoplastic antishock material. Standard 3/4" taper. Complete with hub.

UFL-V32N	3 SPOKE STEERING WHEEL WITH HUB . . . . .	\$ 29.75
----------	---	----------

## UFLEX V33 STEERING WHEEL

Thermoplastic antishock material. Standard 3/4" taper. Complete with hub.

UFL-V33N	STEERING WHEEL WITH HUB . . . . .	\$ 32.50
----------	-----------------------------------	----------

## UFLEX CORSE STEERING WHEEL

Standard 3/4" taper. Die cast aluminum hub included. Meet with the EN 28848 and ABYC P22 standards. Soft touch grip.

UFL-CORSE-G/S	13.8" DIA. STEERING WHEEL . . . . .	\$ 117.60
---------------	-------------------------------------	-----------

## UFLEX V60 ANTIGUA STEERING WHEELS

Thermoplastic antishock material. Standard 3/4" taper. Complete with hub.

UFL-V60	BLACK STEERING WHEEL WITH HUB . . . . .	\$ 49.95
UFL-V60-GRAY	GRAY STEERING WHEEL WITH HUB . . . . .	\$ 49.95

## UFLEX NON-MAGNETIC DESTROYER SS STEEL 5 SPOKE WHEEL

Uflex Non-Magnetic Destroyer Stainless Steel 5 Spoke Steering Wheel, V70, with firm grip is constructed of thermoplastic antishock material, and is designed and built for a lifetime of comfortable service. Exclusive polyurethane "Firm Grip" Standard 3/4" taper. Complete with hub. Meets with the EN 28848 and ABYC P22 safety standards.

UFL-V70B	5 SPOKE BLACK POLY-GRIP . . . . .	\$ 111.99
----------	-----------------------------------	-----------

## SCMITT & ONGARO MARINE STEERING WHEELS

Classic Italian styling at an affordable price. Our Fantasy wheels feature modern styling that will enhance the look of any power boat. The 3/4" tapered hub fits most steering systems. 13-3/4" Diameter. 3/4" Tapered shaft. Black polyurethane grip

SMT-PU013101	FANTASY WHEEL BRUSHED ALUM. SPOKES . . .	\$ 68.95	F
SMT-PU023101	FOLLETTO WHEEL BRUSHED ALUM SPOKES . . .	\$ 75.95	F
SMT-PU026101	FOLLETTO WHEEL POLISHED ALUM SPOKES . . .	\$ 75.95	F

## SCMITT & ONGARO MARINE DESTROYER WHEELS

This stainless-steel steering wheel has an oval shaped 15" diameter rim provides easy gripping. Solid stainless center cap, for Morse and Teleflex steering systems. Non magnetic—will not alter compass readings. Five spokes. 3/4" Tapered.

SMT173-1321FGK	13" DIAMETER WHEEL . . . . .	\$ 84.95	F
SMT173-1521FGK	15" DIAMETER WHEEL . . . . .	\$ 84.95	F

## TELEFLEX K-11 CYLINDER

Aluminum cylinder. Ball joint mount, unbalanced. 1-1/4" bore and 9" stroke. 11 cu/in. displacement. 515 output force / 500psi relief. 950 output force / 950psi relief.

TEL-HC5380HY CYLINDER ONLY.....\$ 637.99 G



## HYNAUTIC SEPARATE STEERING COMPONENTS

HYN-KF100 MERCURY O/B ADAPTER.....\$ 74.39 \* E  
 HYN-KF106 TILLER EXT FOR K6 HELM.....\$ 87.49 \* G  
 HYN-KF107 OMC PLATE FOR K6 HELM.....\$ 193.49 \* G

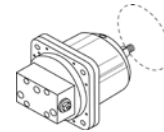

## TELEFLEX SEASTAR NO FEED BACK HYDRAULIC STEERING SYSTEM KIT

Front mount outboard hydraulic steering. Total power to 600 HP. Fully independent engine tilt for twin engines. Easy steering. 5 turns lock to lock. Two cylinder types available: Standard and Compact for narrow splashwells. Includes: Helm, cylinder, mounting hardware and 2 quarts of oil. **ORDER HYDRAULIC HOSE ASSEMBLIES SEPARATELY.**

TEL-HK6400A HYDRAULIC STEERING KIT.....\$1131.49 G  
 TEL-HH5271 HELM.....\$ 490.49 G  
 TEL-HC5345 CYLINDER.....\$ 613.49 G  
 TEL-HA5430 32 OZ. OIL.....\$ 22.39 G  
 TEL-HA5440 GALLON HYDRAULIC FLUID.....\$ 87.49 G  
 TEL-HO5035 MERCURY ADAPTER KIT.....\$ 94.99 G  
 TEL-HO5028 HONDA SINGLE ADAPTER KIT.....\$ 107.99 G  
 TEL-HO5102 2' O/B HOSE KIT (2 PER KIT).....\$ 115.49 G  
 TEL-HO5104 4' O/B HOSE KIT (2 PER KIT).....\$ 115.49 G  
 TEL-HO5105 5' O/B HOSE KIT (2 PER KIT).....\$ 115.49 G  
 TEL-HO5106 6' O/B HOSE KIT (2 PER KIT).....\$ 115.49 G  
 TEL-HO5108 8' O/B HOSE KIT (2 PER KIT).....\$ 115.49 G  
 TEL-HO5110 10' O/B HOSE KIT (2 PER KIT).....\$ 115.49 G  
 TEL-HO5112 12' O/B HOSE KIT (2 PER KIT).....\$ 115.49 G  
 TEL-HO5114 14' O/B HOSE KIT (2 PER KIT).....\$ 115.49 G  
 TEL-HO5116 16' O/B HOSE KIT (2 PER KIT).....\$ 119.99 G  
 TEL-HO5118 18' O/B HOSE KIT (2 PER KIT).....\$ 123.99 G  
 TEL-HO5120 20' O/B HOSE KIT (2 PER KIT).....\$ 133.99 G  
 TEL-HO5122 22' O/B HOSE KIT (2 PER KIT).....\$ 158.99 G  
 TEL-HO5124 24' O/B HOSE KIT (2 PER KIT).....\$ 168.49 G  
 TEL-HO5126 26' O/B HOSE KIT (2 PER KIT).....\$ 210.49 G  
 TEL-HO5128 28' O/B HOSE KIT (2 PER KIT).....\$ 226.49 G  
 TEL-HO5130 30' O/B HOSE KIT (2 PER KIT).....\$ 235.49 G  
 TEL-HS5176 SEAL KIT SEASTAR PRO, & SEASTAR HELMS..\$ 50.99 G  
 TEL-HA5418 BACK PLATE KIT.....\$ 33.99 G  
 TEL-HA5431 SEASTAR VENT PLUG.....\$ 12.39 G  
 TEL-HA5438 SEASTAR BOTTLE FILLER KIT.....\$ 17.49 G

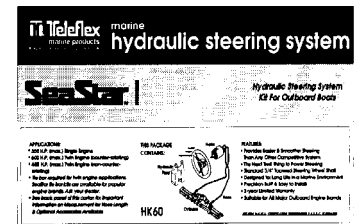

## TELEFLEX SEASTAR PRO NO FEED BACK HYDRAULIC STEERING SYSTEM KIT

Front mount outboard hydraulic steering in a totally self contained, non power assisted unit for high speed power boats. 300 HP max single engine power. Provides the highest level of steering control, response and comfort. Requires only a 3" dash hole and has only a 4-7/26" footprint. Two cylinder types available: Standard and Compact for narrow splashwells. Includes: Helm, cylinder, mounting hardware and 2 quarts of oil. **ORDER HYDRAULIC HOSE ASSEMBLIES SEPARATELY.**

TEL-HK7400A SEASTAR PRO.....\$1150.49 G  
 TEL-HC5345 FRONT MOUNT CYLINDER.....\$ 613.49 G  
 TEL-HH6190 SEASTAR PRO-SERIES TILT HELMS 2.0.....\$ 827.49 G  
 TEL-HA5430 32OZ HYDRAULIC FLUID.....\$ 22.39 G  
 TEL-HA5440 GALLON HYDRAULIC FLUID.....\$ 87.49 G  
 TEL-HO5035 MERCURY ADAPTER KIT.....\$ 94.99 G  
 TEL-HO5714 2 - 14' HYD HOSES.....\$ 223.99 G  
 TEL-HO5716 2 - 16' HYD HOSES.....\$ 244.99 G  
 TEL-HO5718 2 - 18' HYD HOSES.....\$ 265.49 G  
 TEL-HO5720 2 - 20' HYD HOSES.....\$ 285.99 G  
 TEL-HS5176 SEAL KIT SEASTAR PRO, & SEASTAR HELMS..\$ 50.99 G





# Teleflex Morse Cross Reference Table

Discontinued Morse Part No.	Description	Teleflex Morse Reorder Part No.	Description
<b>Steering Products</b>			
300619-000-	Command 200 Rack Cable -Std.	SSC130XX	Teleflex Rack and Pinion Cable for C200 Steering
300620-000-	Command 200 Rack Cable -Stainless core	SSC130XX	Teleflex Rack and Pinion Cable for C200 Steering
304411-000-	Command 290 Rotary Cable -Std	SSC52XX	Teleflex Rotary Steering Cable for C290 Steering
304415-000-	Command 290 Rotary Cable -TRC version	SSC61XX or SSC72XX	Teleflex Rotary Steering Cables for Teleflex Steering
306893	Adapter for SSC72 cable to fit C290 Helm	3924516P	Adapter for SSC72 cable to fit C290 Helm
309273-000-	Command 290 Rotary Steering System	SS137XX	Teleflex Safe-T Steering System (Helm, Bezel, Cable)
309816-000-	Command 200 Rack and Pinion Steering System	SS141XX	Teleflex Rack Steering System (Helm, Bezel, Cable)
311921-000-	Command 290 NFS Steering System	SS147XX	Teleflex 4.2 NFB Steering System (Helm, Bezel, Cable)
312020-000-	Universal Rotary Steering Cable -Universal	SSC61XX (Teleflex)	Teleflex QCII Rotary Steering Cable for Safe-T Systems
		SSC52XX (Morse)	Teleflex Rotary Steering Cable for C290 Steering
<b>Control Cables</b>			
046348-003-	43BC Cable	CC692XX	Teleflex Xtreme 43BC Cable
048296-000-	Type O Cable (Older OMC applications)	CC170XX	Teleflex Type O Cable
063732-000-	KM Cable (Mercury/Mercruiser applications)	CC179XX	Teleflex Type KM Cable
065885-003-	43C Cable	CC693XX	Teleflex Xtreme 43C Cable
302029-000-	Type OS Cable (Newer OMC applications)	CC205XX	Teleflex Type OS Cable
304262-004-	64XLC Cable	CC695XX	Teleflex Xtreme 64C Cable
304263-004-	64XLBC Cable	CC694XX	Teleflex Xtreme 64BC Cable
310048-000-	Type OC Cable	CC740XX	Teleflex OMC/SAE Cable
310530-000-	33SPL Cable (Mercury Sport Jet)	CC213XX	Teleflex Mercury Sport Jet Cable

(XX= Determined Length)

## TELEFLEX SEASTAR POWER ASSIST UNIT

Dramatically increases steering comfort. Reduced wheel effort. Easy installation. Simple 'add-on' to existing SeaStar manual system (up to 2.0cu. in. helms). Number of turns lock to lock remains the same. Compatible with SeaStar Power Purge system. Compatible with autopilots. Wiring harness included. Ignition protected (SAE J-1171), 12VDC. ABYC, CE, NMMA, ISO 10592 Approved. Perfect addition for all O/B, I/O, I/B powered boats, equipped with standard hydraulic steering. 150HP+ single outboards. Heavy 4 stroke outboards. Twin/Triple outboards. Inboards where rudder torque makes wheel effort heavy or uncomfortable.



TEL-PA1200-2 STEERING POWER ASSIST UNIT .....\$1985.00 G

## TELEFLEX SEASTAR HYDRAULIC STEERING HELMS

TEL-HH5272 SEASTAR II HELM .....\$ 614.99 G  
 TEL-HH5250 HELM PUMP .....\$ 942.49 G  
 TEL-HA5432 NON-VENT PLUG .....\$ 10.79 G

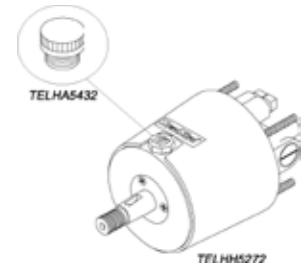

## UFLEX HYDRAULIC TIE BAR FOR TWIN ENGINE TWIN CYLINDER

UFL-LTB1 HYDRAULIC TIE BAR .....\$ 310.45



## UFLEX HYDRAULIC HELM FRONT MOUNT

Uflex Front Mount Hydraulic Helm Pumps are available in three different displacement sizes and feature a ball bearing piston race with a built in lock valve for positive rudder lock. Ball bearing piston race. Built in lock valve. Integral relief valve for over-pressure protection. 3/4" tapered shaft. Cast iron rotor. 1/4" NPT fitting for 3/8" tube. Complete with elbow fittings. Drop in replacement for Teleflex Seastar helms. Maximum Wheel Diameter 28". Relief valve setting 70bar-1000psi.

UFL-UP33FM FRONT MOUNT HYDRAULIC HELM .....\$ 610.95



## TELEFLEX SEASTAR HYDRAULIC STEERING CYLINDERS

TEL-HC5314-3 I/B BA150 - 7ATM .....\$ 461.99 G  
 TEL-HC5318 I/B BA150 - 77TM .....\$ 791.49 G  
 TEL-HC5319 I/B BA175 - 7TM .....\$ 892.99 G  
 TEL-HC5326 I/O BA150 - 7EM .....\$ 564.99 G  
 TEL-HC5328-3 I/O 125 - 8EMV STERN .....\$ 474.99 G  
 TEL-HC5329 I/O 125 - 8VPEM STERN .....\$ 525.99 G  
 TEL-HC5330 STERN DRIVE BA125-EMV CYLINDER .....\$ 490.49 G  
 TEL-HC5331 VOLVO I/O ALL MODELS 92VPS .....\$ 564.99 G  
 TEL-HC5345 O/B FR. MT PIVOT CYLINDER .....\$ 613.49 G  
 TEL-HC5347 O/B FR. MT PIVOT CYL. HONDA 115-130 ..\$ 712.99 G  
 TEL-HC5348 O/B FR. MT PIVOT CYL. OMC 77-90 .....\$ 712.99 G  
 TEL-HC5358 YAMAHA O/B 4 STROKE 'CYCLINDER' .....\$ 641.49 G  
 TEL-HC5370 O/B SIDE MOUNT CYLINDER .....\$ 465.99 G  
 TEL-HC5355 CAPILANO BA150 - 7TMC .....\$ 845.49 G  
 TEL828980 PIVOT CYLINDER, BLEEDER FITTING .....\$ 6.79 G





## TELEFLEX SEASTAR FRONT MOUNT PRO CYLINDER

SeaStar front mount steering cylinder is designed for single and twin non-power assisted outboard engines up to 300HP, cruisers, runabouts, offshore fishing boats and more. Suitable for speeds up to 60MPH.

TEL-HC6345      HYDRAULIC FRONT MOUNT PRO CYL. ....\$ 820.49 G

## TELEFLEX SEASTAR HYDRAULIC STEERING COMPONENTS

TEL-H05035	MERCURY SINGLE 75-275HP 89 & UP.....\$	94.99	G
TEL-HS5147	BAYSTAR FRONT MOUNT & SPORT TILT HELMS\$	9.59	G
TEL-HS5154	SEAL KIT, 125EM,ATM.....\$	33.89	G
TEL-HS5155	SEAL KIT, 135EM,MV,BJ,ATM.....\$	33.89	G
TEL-HS5159	SEARAY CYLINDER SEAL KIT.....\$	53.49	G
TEL-HS5161	SEAL KIT CAPILANO HELM 1250/1275.....\$	40.59	G
TEL-HS5182	SEAL KIT CYLINDERS HC5318 HC5369.....\$	43.69	G
TEL-HS5183	SEAL KIT CYLINDERS HC5350 HC5356.....\$	48.29	G
TEL-HF5502	FITTING KIT TO ADD AN AUTOPILOT TO AN INBOARD OR STERNDRIVE SYSTEM....\$	57.49	G
TEL-HF5508	SEASTAR II CYLINDER HOSE KIT TO CONNECT 3/8" DIAMETER COPPER TUBING TO SEASTAR CYLINDERS (2) TUBE NUT - 3/8" DIAMETER (2) CONNECTOR FITTING 3/8" TUBE (2) 18' HOSE C/W FITTINGS .....	89.49	G
TEL-HT5095	SEASTAR NYLON TUBING 3/8" 50'.....\$	102.99	G
TEL-HF5529	SEASTAR ELBOW TUBE 1/4" NPT 3/8" PACK OF 3.....\$	27.29	G
TEL-HF5548	BAYSTAR BLEEDER KIT.....\$	18.49	G
TEL-HS5157	SEAL KIT W/WRENCH,HC5340/5342/5345....\$	121.49	G
TEL-HS5167	SEAL KIT, HC5340/5342/5345.....\$	98.49	G
TEL-H06001	TIEBAR KIT,SINGLE CYLINDER TWIN ENGINE.....\$	368.49	G
TEL-HF5521	BLEEDER KIT 3/8 TUBE 1/4 NPT & BLEEDER NIP.....\$	54.49	G

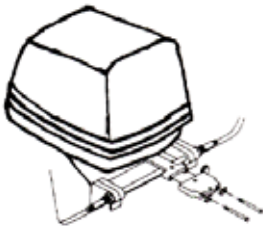

## TELEFLEX SEASTAR STEERING CYLINDER ROD END ADAPTER KIT

TEL-HA5424      CYLINDER ROD END ADAPTER.....\$ 53.99 G



## TELEFLEX BAYSTAR STEERING KIT

BayStar kits come complete with everything needed for an install. The cylinder utilizes the factory outboard engine supplied drag link for simplified installation. For your convenience two lengths of 20' cut to fit tubing are supplied (2 x 20' length). For motors up to 150 HP. **Kit includes:**

- BayStar Helm Pump (HH4016)
- BayStar Cylinder (HC4600)
- BayStar Tubing Kit (HT4425)
- 2 Bottles of hydraulic steering fluid (HA5430)
- Filler Kit (HA5438)

TEL-HK4200A      BAYSTAR HYD KIT WITH HOSE.....\$ 751.99 G



**TELEFLEX POWER PURGE JR.**

The easy way to 100% purge air out of BayStar and SeaStar hydraulic steering systems. The Power Purge Jr. reduces installation and warranty costs while enhancing the quality of the boat to the end user. A typical manual fill and purge takes the average experienced installer or service technician about 30 minutes per boat - by using the Power Purge Jr. this can be reduced to 10 minutes or less.

TEL-HA5445-2      POWER PURGE JR. . . . . \$ 876.99 G



**UFLEX "HYCO" INBOARD HYDRAULIC STEERING SYSTEM**

HYCO-I WHEEL TURNS 3,4. Package kit contains: 1 #UP20 F Front mount helm pump. 1 #UC69-I Inboard cylinder. #OIL 15 Hydraulic oil - 2 quarts. KIT OB OPTIONAL Hose kit with preassembled fittings. Specify length required when ordering. The wheel is not included. HYCO-I steering system is suitable for inboard boats up to approx. 28 - 30 ft (8,5 - 9 m) length and 25 mph max speed.

UFL-HYCO1.0      HYDRAULIC SYSTEM "HOSES SEPERATE" . . . . \$ 927.00



**UFLEX "PROTECH 1.0" OUTBOARD HYDRAULIC STEERING SYSTEM**

PROTECH WHEEL TURNS 4,5. Package kit contains: 1 #UP28 F Front mount helm pump. 1 #UC128-OBF Front mount outboard cylinder. Specify engine type when ordering. #OIL 15 Hydraulic oil - 2 quarts. KIT OB OPTIONAL Hose kit with preassembled fittings. Specify length required when ordering. The wheel is not included.

UFL-PT1.0      HYDRAULIC SYSTEM "HOSES SEPERATE" . . . . \$1198.00



**UFLEX HYDRAULIC HOSE KITS**

It consists of a pair of high pressure flexible hoses supplied with pre-assembled fittings on both ends.

- UFL-KITOB10      10' HOSES PRE-ASSEMBLED FITTINGS . . . . \$ 148.95
- UFL-KITOB12      12' HOSES PRE-ASSEMBLED FITTINGS . . . . \$ 148.95
- UFL-KITOB14      14' HOSES PRE-ASSEMBLED FITTINGS . . . . \$ 148.95
- UFL-KITOB16      16' HOSES PRE-ASSEMBLED FITTINGS . . . . \$ 148.95
- UFL-KITOB18      18' HOSES PRE-ASSEMBLED FITTINGS . . . . \$ 148.95
- UFL-KITOB20      20' HOSES PRE-ASSEMBLED FITTINGS . . . . \$ 148.95
- UFL-KITOB22      22' HOSES PRE-ASSEMBLED FITTINGS . . . . \$ 148.95
- UFL-KITOB24      24' HOSES PRE-ASSEMBLED FITTINGS . . . . \$ 148.95
- UFL-KITOB26      26' HOSES PRE-ASSEMBLED FITTINGS . . . . \$ 148.95



**T-H MARINE STEER LOCK FOR HYDRAULIC STEERING**

Stops outboards equipped with hydraulic steering from "wandering" when trailering. Units clip onto hydraulic steering rams on either side of outboard to keep engine straight and prevent damage to motor supports. Cord keeps units together when stowed and aids removal.

TNH-SS1-DP      STEER LOCK . . . . . \$ 16.79

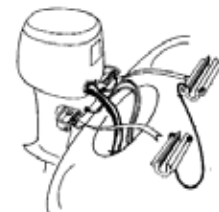

**STEERING**

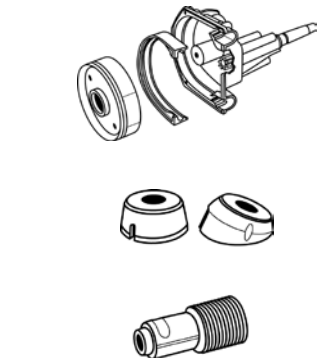

## RACK & PINON STEERING SYSTEM

Complete steering systems include helm, cable and 90 degree bezel. Wheel not included. Bolt in replacement for Morse and other steering systems with no new holes to drill. Quality cable with stainless output ends. Uses 300252 Helm, 300619 Cable.

MOR30981609 9' .....\$ 146.00 \*

## COMMAND 200 RACK & PINON STEERING RUDDER POSITION INDICATOR

Used with Command 200 steering system.

MOR300255 RUDDER POSITION INDICATOR .....\$ 32.20 \*

## COMMAND 200 STEERING CABLE - STAINLESS END

Extra long life - stainless steel version.

MOR30062010 10' CABLE .....\$ 249.09 \*  
 MOR30062011 11' CABLE .....\$ 252.64 \*  
 MOR30062019 19' CABLE .....\$ 281.16 \* G

## TELEFLEX COMMAND 200 STEERING CABLE

Command 200 rack and pinion steering.

TEL-SSC13010 10' RACK CABLE .....\$ 154.99  
 TEL-SSC13011 11' RACK CABLE .....\$ 154.99  
 TEL-SSC13012 12' RACK CABLE .....\$ 154.99  
 TEL-SSC13013 13' RACK CABLE .....\$ 154.99  
 TEL-SSC13014 14' RACK CABLE .....\$ 154.99  
 TEL-SSC13015 15' RACK CABLE .....\$ 154.99  
 TEL-SSC13016 16' RACK CABLE .....\$ 154.99  
 TEL-SSC13017 17' RACK CABLE .....\$ 154.99  
 TEL-SSC13018 18' RACK CABLE .....\$ 154.99  
 TEL-SSC13019 19' RACK CABLE .....\$ 154.99  
 TEL-SSC13020 20' RACK CABLE .....\$ 154.99  
 TEL-SSC13021 21' RACK CABLE .....\$ 220.99  
 TEL-SSC13022 22' RACK CABLE .....\$ 224.99  
 TEL-SSC13023 23' RACK CABLE .....\$ 228.49  
 TEL-SSC13024 24' RACK CABLE .....\$ 232.49

## COMMAND 290 ROTARY STEERING COMPONENTS

Has a combination of features not available on other systems. Meets or exceeds industry standards. Choice of cable entry for easy installation. High durability with heavy duty castings, machined drive gear, one-piece steel pinion shaft, protective internal cable core backup ring and corrosion resistant components. Uses Command 290 cable. Designed to mount to the wheel in two positions, 90 degrees parallel to dash and 20 degrees from parallel. Optimal friction brake available, to dampen torque feedback. Drop in replacement for Teleflex SafeT, functional replacement for Teleflex Big T. Quick to install, cable attaches to helm with single bolt and nut. Compact lightweight design.

MOR292525 SINGLE HELM/NO BRAKE .....\$ 115.99  
 MOR304857 SINGLE HELM WITH BRAKE .....\$ 126.99  
 MOR308559 90 DEGREE BLACK BEZEL .....\$ 35.49  
 MOR308561 20 DEGREE BLACK BEZEL .....\$ 33.49  
 MOR301098 REPLACEMENT TAKE UP TUBE .....\$ 17.09 \*  
 MOR309305 CABLE ADAPTER FOR NFB/SNAP-IN .....\$ 24.99  
 MOR305015 TWIN HELM WITH BRAKE .....\$ 369.48

## COMMAND 290 - TRC - STEERING CABLE

MOR-TRC10	10' CABLE.....	\$ 182.65 * J
MOR-TRC13	13' CABLE.....	\$ 192.39 * J



## COMMAND 2 ROTARY STEERING CABLE ONLY

Replaces original Command 2 numbers 68764, 300621, 300622, 300623 and 300624. 5' minimum bend radius. Order plastic "B" dimension plus 22"= order length (round up to nearest foot). These cables fit helm no. D300376.

MOR30062211	11' CABLE ONLY.....	\$ 272.29 *
MOR30062212	12' CABLE ONLY.....	\$ 276.31 *



## "URC" UNIVERSAL REPLACEMENT ROTARY CABLE

For Morse, Teleflex and Uflex rotary steering systems, including no-feedback versions. Replaces Teleflex SC-72, SSC-72, SC-106, SSC-62 and SSC-62NFB. Replaces Uflex M47, T71, T72, T73NR, T79NR, T81, T82, T83NR, T84NR, M63 and SAFETQC. Kit includes a 304411 cable and a 306983 cable kit helm end.

MOR-URC11	11' URC CABLE .....	\$ 136.78
-----------	---------------------	-----------

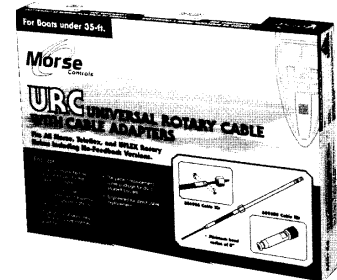

## "TRRC" RACK AND PINION CABLE

Morse 308664 cable replaces Teleflex SSC124 cable.

MOR-TRRC17	17' TRRC CABLE ONLY.....	\$ 149.32 * J
------------	--------------------------	---------------



## STEERING CONNECTION KITS

Most boats and engines are supplied complete with steering cable connection kits.

- 64480 Aluminum support tube
- 300609 Thru hinge pin kit for 1973 and later Johnson/Evinrude 50HP and up. All Mercury 40HP and up except V-6's.
- 300610 Transom mount front hookup - galvanized.
- 300611 Transom mount front hookup - SST
- 300612 Adapter bracket for Johnson/Evinrude 40HP under
- 300613 Splashwell mount
- 300617 2" short inboard bracket
- 300618 Swivel assembly only
- 308949 Outboard dual cable steering kit

MOR64480	TUBE.....	\$ 44.39
MOR300609	HINGE PIN KIT.....	\$ 117.11 *
MOR300610	HOOKUP - GALV.....	\$ 192.99
MOR300611	HOOKUP - SST.....	\$ 259.99
MOR300613	SPLASHWELL MOUNT.....	\$ 232.99 *
MOR300617	BRACKET.....	\$ 138.99
MOR300618	SWIVEL ASSY.....	\$ 51.49 *
MOR308949	DUAL CABLE KIT.....	\$ 338.49

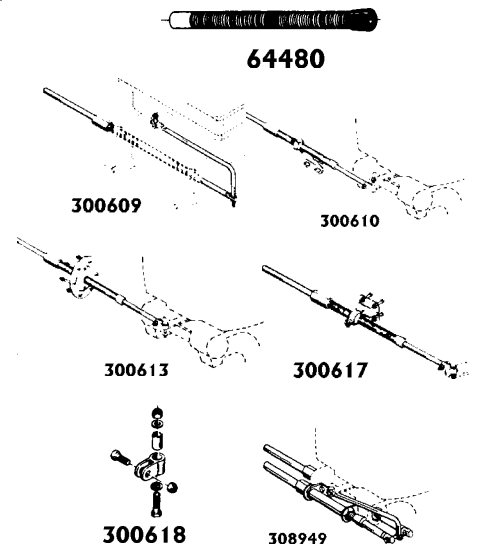

## RACK AND PINION THROUGH TRANSOM ADAPTER KIT

Used to replace OMC through transom ball type cable with late model steering cable.

SWY-OMC	OMC BALL TYPE CABLE ADAPTER.....	\$ 284.00
---------	----------------------------------	-----------



## TELEFLEX SS137 SAFE-T QUICK CONNECT ROTARY SYSTEM

For boats up to 24'. No tools required to connect cable to the helm. Twin cable system recommended for boats that exceed 50MPH. Compact rotary helm occupies minimum space behind the dashboard. 3 turns lock to lock. Stainless steel cable output ends. Standard 3/4" tapered shaft. Exceeds BIA and ABYC standards. Order TELSS137-Length. Example: TELSS13715 is a 15' system.

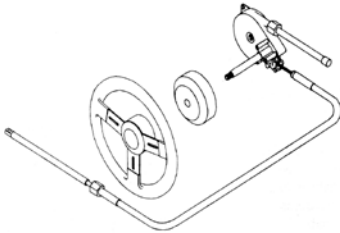

TEL-SS137**	PLEASE SPECIFY LENGTH(8'-20')	\$ 193.99
TEL-SS13721	21'	\$ 201.99
TEL-SS13722	22'	\$ 207.99
TEL-SS13723	23'	\$ 213.99
TEL-SH5294P	DUAL HELM	\$ 362.49
TEL-SH5094P	SINGLE HELM	\$ 82.49
TEL-SH91523P	SAFE T QC TILT HELM SINGLE	\$ 136.99
TEL-SB27483P	20 DEG. BEZEL	\$ 31.59
TEL-SB27484P	90 DEG. BEZEL	\$ 21.69

## TELEFLEX SS141 BACK MOUNT RACK AND PINION SYSTEM

For boats up to 24'. Twin cable system recommended for boats that exceed 50MPH. Back mount design for easy installation. 4 turns lock to lock. Stainless steel telescopic ram. Standard 3/4" tapered shaft. Meets BIA and ABYC standards. Order TELSS141-Length. Example: TELSS14115 is a 15' system. Components: SSC134\*\*-cable only, SB39526P 90 deg. bezel.

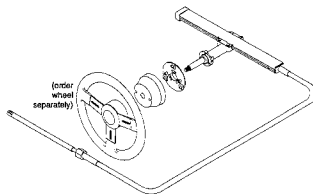

TEL-SS14108	8'	\$ 193.99
TEL-SS14109	9'	\$ 193.99
TEL-SS14110	10'	\$ 193.99
TEL-SS14111	11'	\$ 193.99
TEL-SS14112	12'	\$ 193.99
TEL-SS14113	13'	\$ 193.99
TEL-SS14114	14'	\$ 193.99
TEL-SS14115	15'	\$ 193.99
TEL-SS14116	16'	\$ 193.99
TEL-SS14117	17'	\$ 193.99
TEL-SS14118	18'	\$ 193.99
TEL-SS14119	19'	\$ 193.99
TEL-SS14120	20'	\$ 193.99
TEL-SH5210P	HELM	\$ 69.99
TEL-SB39526P	90 DEG BACK MT BEZEL	\$ 21.89
TEL-SH91610P	TILT HELM FOR BACK MOUNT RACK	\$ 111.99
TEL-SH1535230	TILT HELM AND TILT MECHANISM	\$ 310.99

## TELEFLEX SS132 SAFE-T II NO FEED BACK ROTARY SYSTEM

Patented no feed back technology. For boats up to 24'. Compact rotary helm occupies minimum space behind the dashboard. 3 turns lock to lock. Stainless steel cable output ends. Standard 3/4" tapered shaft. Meets NMMA and ABYC standards. Uses SB27483P 20 deg. bezel or SB27150P 90 deg. bezel. Can be used for port or starboard side steering

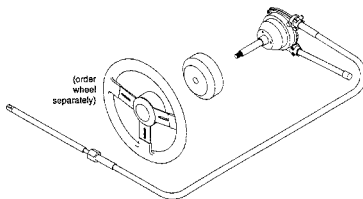

TEL-SS13210	10'	\$ 253.99
TEL-SS13211	11'	\$ 253.99
TEL-SS13212	12'	\$ 253.99
TEL-SS13213	13'	\$ 253.99
TEL-SS13214	14'	\$ 253.99
TEL-SS13215	15'	\$ 253.99
TEL-SS13216	16'	\$ 253.99
TEL-SS13217	17'	\$ 253.99
TEL-SS13218	18'	\$ 253.99
TEL-SS13219	19'	\$ 253.99
TEL-SS13220	20'	\$ 253.99
TEL-SH5150P	HELM	\$ 152.99
TEL-SH91190P	TILT HELM FOR NFB ROTARY	\$ 165.49
TEL-SH1534910	TILT HELM AND TILT MECHANISM	\$ 370.49

## TELEFLEX SS147 NO FEED BACK ROTARY SYSTEM

Patented no feed back technology, eliminates torque feedback at the helm. For boats up to 24'. Compact rotary helm occupies minimum space behind the dashboard. 4.2 turns lock to lock. Standard 3/4" tapered shaft. Wheels up to 16". Meets NMMA and ABYC standards. Components: SH4910P helm, SSC61\*\* cable, SB27483 20 deg. bezel, SB27150p 90 deg. bezel.

TEL-SS14710	10'	.....	\$ 260.99
TEL-SS14711	11'	.....	\$ 260.99
TEL-SS14712	12'	.....	\$ 260.99
TEL-SS14713	13'	.....	\$ 260.99
TEL-SS14714	14'	.....	\$ 260.99
TEL-SS14715	15'	.....	\$ 260.99
TEL-SS14716	16'	.....	\$ 260.99
TEL-SS14717	17'	.....	\$ 260.99
TEL-SS14718	18'	.....	\$ 260.99
TEL-SS14719	19'	.....	\$ 260.99
TEL-SS14720	20'	.....	\$ 260.99
TEL-SH4910P	4.2	ROTARY NFB SINGLE HELM.....	\$ 153.99
TEL-SB27150P	NFB	BEZEL 90DEG.....	\$ 21.89

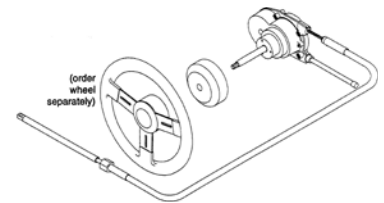

## TELEFLEX SS148 NO FEED BACK DUAL ROTARY SYSTEM

Patented no feed back technology, eliminates torque feedback at the helm. For boats up to 24'. Compact rotary helm occupies minimum space behind the dashboard. 4.2 turns lock to lock. Standard 3/4" tapered shaft. Wheels up to 16". Meets NMMA and ABYC standards.

TEL-SS14812	12'	DUAL ROTARY NFB SYSTEM.....	\$ 559.99
TEL-SS14813	13'	DUAL ROTARY NFB SYSTEM.....	\$ 564.99
TEL-SS14814	14'	DUAL ROTARY NFB SYSTEM.....	\$ 570.49
TEL-SS14815	15'	DUAL ROTARY NFB SYSTEM.....	\$ 575.99
TEL-SS14816	16'	DUAL ROTARY NFB SYSTEM.....	\$ 581.49

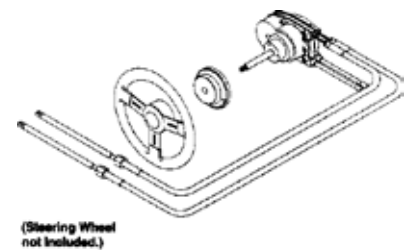

## TELEFLEX SS151 NO FEED BACK RACK/PINION SYSTEM

Patented no feed back technology for boats up to 24'. 4 Turns lock to lock. Stainless steel telescopic ram. Standard 3/4" tapered shaft. Meets NMMA and ABYC standards. Components: SH5230P helm, SB39544P 90 deg bezel, SB27449P 20 deg. wedge, SSC134\*\* cable only.

TEL-SB39544P	BEZEL KIT 90°	.....	\$ 22.89
TEL-SS15110	10'	RACK NFB SYSTEM.....	\$ 284.49
TEL-SS15111	11'	RACK NFB SYSTEM.....	\$ 287.49
TEL-SS15112	12'	RACK NFB SYSTEM.....	\$ 290.49
TEL-SS15113	13'	RACK NFB SYSTEM.....	\$ 280.49
TEL-SS15114	14'	RACK NFB SYSTEM.....	\$ 283.49
TEL-SS15115	15'	RACK NFB SYSTEM.....	\$ 286.49
TEL-SS15116	16'	RACK NFB SYSTEM.....	\$ 289.49
TEL-SS15117	17'	RACK NFB SYSTEM.....	\$ 306.49
TEL-SS15118	18'	RACK NFB SYSTEM.....	\$ 309.49
TEL-SS15119	19'	RACK NFB SYSTEM.....	\$ 312.49
TEL-SS15120	20'	RACK NFB SYSTEM.....	\$ 315.99

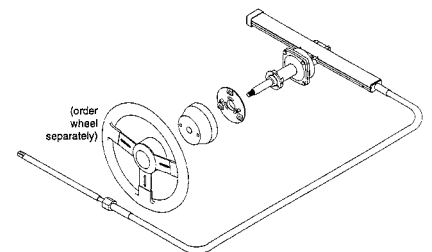

## TELEFLEX BACK MOUNT RACK CABLE ONLY

Replacement steering cable for the Teleflex "Back Mount Rack" steering system

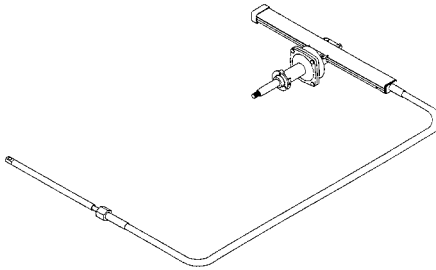

TEL-SSC13412	12'	BACK MOUNT RACK CABLE	\$ 154.49
TEL-SSC13413	13'	BACK MOUNT RACK CABLE	\$ 157.49
TEL-SSC13414	14'	BACK MOUNT RACK CABLE	\$ 160.49
TEL-SSC13415	15'	BACK MOUNT RACK CABLE	\$ 163.49
TEL-SSC13416	16'	BACK MOUNT RACK CABLE	\$ 165.99
TEL-SSC13417	17'	BACK MOUNT RACK CABLE	\$ 168.99
TEL-SSC13418	18'	BACK MOUNT RACK CABLE	\$ 171.99
TEL-SSC13419	19'	BACK MOUNT RACK CABLE	\$ 205.99
TEL-SSC13420	20'	BACK MOUNT RACK CABLE	\$ 209.49
TEL-SSC13421	21'	BACK MOUNT RACK CABLE	\$ 227.49
TEL-SSC13422	22'	BACK MOUNT RACK CABLE	\$ 231.49
TEL-SSC13423	23'	BACK MOUNT RACK CABLE	\$ 234.99
TEL-SSC13424	24'	BACK MOUNT RACK CABLE	\$ 238.49
TEL-SSC13426	26'	BACK MOUNT RACK CABLE	\$ 253.49
TEL-SSC13428	28'	BACK MOUNT RACK CABLE	\$ 268.49
TEL-SSC13430	30'	BACK MOUNT RACK CABLE	\$ 283.49

## TELEFLEX SS152 NO FEED BACK DUAL RACK SYSTEM

Patented no feed back technology. For boats up to 24'. 4 turns lock to lock. Stainless steel telescopic ram. Standard 3/4" tapered shaft. Meets NMMA and ABYC standards.

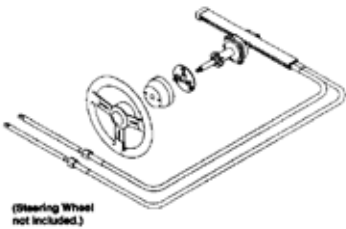

TEL-SS15212	12'	DUAL RACK NFB SYSTEM	\$ 537.49
TEL-SS15213	13'	DUAL RACK NFB SYSTEM	\$ 542.99
TEL-SS15214	14'	DUAL RACK NFB SYSTEM	\$ 548.99
TEL-SS15215	15'	DUAL RACK NFB SYSTEM	\$ 580.99
TEL-SS15216	16'	DUAL RACK NFB SYSTEM	\$ 586.99

## TELEFLEX SSC61 QCII REPLACEMENT ROTARY CABLE

No tools required quick connect cable attachment. Stainless steel telescopic ram. Includes cable guard tilt tube seal nut. Quick connect convertor included. Fits most Teleflex rotary helms from 1968 to present including Safe-T, QC, NFB, SafeT, TS and BigT. SA27620P - quick connect converter.

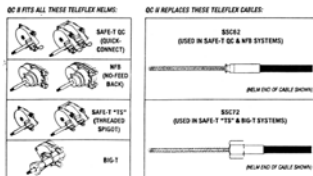

TEL-SA27620P		QUICK CONNECT CONVERTOR	\$ 21.79
TEL-SSC6108	8'	QCII CABLE	\$ 137.99
TEL-SSC6109	9'	QCII CABLE	\$ 137.99
TEL-SSC6110	10'	QCII CABLE	\$ 137.99
TEL-SSC6111	11'	QCII CABLE	\$ 137.99
TEL-SSC6112	12'	QCII CABLE	\$ 137.99
TEL-SSC6113	13'	QCII CABLE	\$ 137.99
TEL-SSC6114	14'	QCII CABLE	\$ 137.99
TEL-SSC6115	15'	QCII CABLE	\$ 137.99
TEL-SSC6116	16'	QCII CABLE	\$ 137.99
TEL-SSC6117	17'	QCII CABLE	\$ 137.99
TEL-SSC6118	18'	QCII CABLE	\$ 137.99
TEL-SSC6119	19'	QCII CABLE	\$ 137.99
TEL-SSC6120	20'	QCII CABLE	\$ 137.99
TEL-SSC6121	21'	QCII CABLE	\$ 221.49
TEL-SSC6122	22'	QCII CABLE	\$ 218.49
TEL-SSC6123	23'	QCII CABLE	\$ 235.99
TEL-SSC6124	24'	QCII CABLE	\$ 243.49
TEL-SSC6125	25'	QCII CABLE	\$ 250.49

## TELEFLEX SSC124 "THE RACK" REPLACEMENT CABLE

Twin cable system recommended for boats that exceed 50MPH. 4 turns lock to lock. Stainless steel cable output ends. Exceeds BIA and ABYC standards.

TEL-SB27449P	20 DEGREE MOUNT KIT .....	\$ 18.69
TEL-SSC12408	8' RACK CABLE .....	\$ 145.49
TEL-SSC12409	9' RACK CABLE .....	\$ 145.49
TEL-SSC12410	10' RACK CABLE .....	\$ 145.49
TEL-SSC12411	11' RACK CABLE .....	\$ 145.49
TEL-SSC12412	12' RACK CABLE .....	\$ 145.49
TEL-SSC12413	13' RACK CABLE .....	\$ 145.49
TEL-SSC12414	14' RACK CABLE .....	\$ 145.49
TEL-SSC12415	15' RACK CABLE .....	\$ 145.49
TEL-SSC12416	16' RACK CABLE .....	\$ 145.49
TEL-SSC12417	17' RACK CABLE .....	\$ 145.49
TEL-SSC12418	18' RACK CABLE .....	\$ 145.49
TEL-SSC12419	19' RACK CABLE .....	\$ 145.49
TEL-SSC12420	20' RACK CABLE .....	\$ 145.49
TEL-SSC12421	21' RACK CABLE .....	\$ 207.99
TEL-SSC12422	22' RACK CABLE .....	\$ 211.49

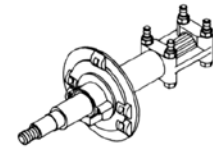

## TELEFLEX SAFE-T THREADED SPIGOT ROTARY HELMS

TEL-SH5023P	"TS" - SINGLE .....	\$ 158.49
-------------	---------------------	-----------

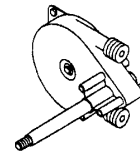

## TELEFLEX BIG-T ROTARY HELM

TEL-SH5000P	BIG-T HELM (SINGLE PUSH-PULL) .....	\$ 318.49
TEL-SB27265P	BEZEL KIT 2-PC BLACK 90/20DEG MOUNT ...	\$ 134.49

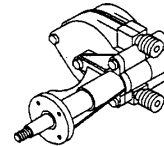

## TELEFLEX DASH TILT MODULES

Dash Modules include helm, tilt mechanism, mounting hardware and instructions.

	FOR NON-POWER STEERED APPLICATIONS:	
TEL-SH1535150	NFB SAFE-T II ROTARY SSC61XX, SSC62XX	\$ 296.99
TEL-SH1534910	NFB 4.2 SINGLE ROTARY SSC61XX, SSC62XX	\$ 370.49
TEL-SH1535230	NFB RACK RACK SSC134XX, SSC135XX .....	\$ 310.99

	FOR POWER STEERED APPLICATIONS:	
TEL-SH1535094	SAFE-T QC SING. ROTARY SSC61XX, SSC62XX	\$ 259.49
TEL-SH1535210	BACK-MOUNT RACK SSC134XX, SSC135XX .....	\$ 239.49



## TELEFLEX PRO SERIES TILT HELM

Preloaded dual taper bearings ensures minimal excess free play. Smooth operation and feel. Shaft seals to prevent water ingress. 48 degrees of tilt articulation. 5 positive lock positions. Compact footprint. Maintenance free. Fits most styled and formed dashes. Patented lock valve system designed for high torque single outboard applications. Flexible Rubber Bellows.

TEL-SH91800P	PRO SERIES TILT HELM .....	\$ 176.49
--------------	----------------------------	-----------



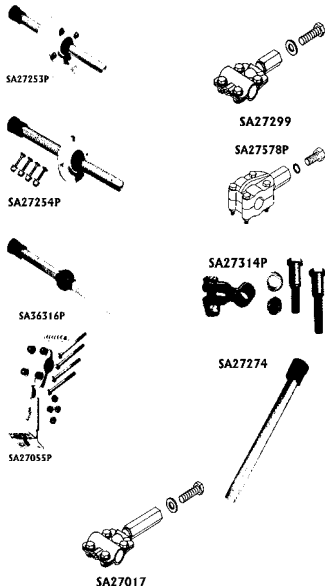

## TELEFLEX STEERING CONNECTION COMPONENTS

- SA27253 - Splashwell mounting kit 15 degree corrosion resistant
- SA27254 - Splashwell mounting kit 90 degree corrosion resistant
- SA36316 - Splashwell threaded tube w/ball corrosion resistant
- SA27055 - Outboard clamp block - stainless steel corrosion resistant
- SA27017 - Inboard clamp block - 4-7/8" stand off corrosion resistant
- SA27299 - Inboard clamp block - 2-5/8" stand off corrosion resistant
- SA27578 - Ski boat inboard clamp block - 2-5/8" stand off black metalflake
- SA27314 - Clevis kit/stainless steel short bolt
- SA27274 - Aluminum support tube
- SA38603 - NFB/SAFE T QC spent travel tube
- SA35680 - SAFE T/BIG T spent travel tube

TEL-SA27253P	15 DEGREE SPLASHWELL .....	\$ 184.49
TEL-SA27254P	90 DEGREE SPLASHWELL .....	\$ 121.49
TEL-SA36316P	SPLASHWELL THREADED TUBE/BALL.....	\$ 45.89
TEL-SA27055P	O/B CLAMP BLOCK .....	\$ 95.49
TEL-SA27578P	SKI I/B CLAMP BLOCK.....	\$ 103.49
TEL-SA27314P	CLEVIS KIT .....	\$ 42.09
TEL-SA27274P	SUPPORT TUBE CLAMP MOUNT.....	\$ 23.99
TEL-SA38603P	NFB SPENT TUBE.....	\$ 9.69
TEL-SA35680P	SAFE-T SPENT TUBE.....	\$ 9.29
TEL-SA27620P	QUICK CONNECT CONVERTER FOR SSC61.....	\$ 21.79

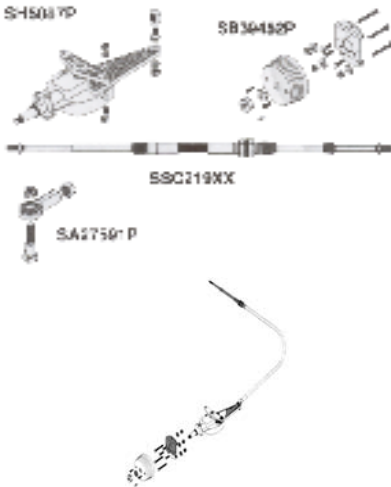

## TELEFLEX SPORT JET STEERING CABLE

TEL-SSC21912	12 FEET .....	\$ 142.49
TEL-SSC21913	13 FEET .....	\$ 152.49
TEL-SSC21914	14 FEET .....	\$ 162.49
TEL-SSC21915	15 FEET .....	\$ 172.49
TEL-SSC21916	16 FEET .....	\$ 182.49
TEL-SSC21917	17 FEET .....	\$ 191.99
TEL-SSC21918	18 FEET .....	\$ 201.99
TEL-SSC21919	19 FEET .....	\$ 211.99
TEL-SSC21920	20 FEET .....	\$ 221.99
TEL-SB39452P	90 DEGREE BEZEL KIT.....	\$ 16.39
TEL-SH5087P	135 DEGREE HELM.....	\$ 134.49
TEL-SA27591P	MERC CONNECTION KIT.....	\$ 72.49

## UFLEX "PROTECH 2.0" OUTBOARD HYDRAULIC STEERING

Universal design fits nearly every two and four stroke outboard engines. Helm features a stainless steel shaft and cast iron rotor for greater strength and durability. 4.5 turns lock to lock for a responsive, yet safe steering performance. Package contains front mount helm pump, front mount outboard cylinder and hydraulic oil (2 quarts). Wheel and hoses not included.

**KIT 95-2S:** Fitting kit for a second steering station or for an autopilot installation. It includes all necessary fittings for 3/8" nylon or copper tube.



UFL-PT2.0	HYDRAULIC SYSTEM "HOSES SEPERATE" .....	\$1198.00
UFL-KIT95-2S	FITTING KIT FOR SECOND STATION.....	\$ 56.79

## UFLEX ROTECH ROTARY STEERING SYSTEM

A convenient kit form, especially suitable as replacement steering, that includes helm, bezel and cable. The cable is available in 1-ft increments from 6 to 25 feet. The wheel is not included.

### ROTARY STEERING SYSTEM

- 1 #T71FC - HELM
- 1 #X34 - 90° BEZEL
- 1 #M66 - ROTARY STEERING CABLE

UFL-R006	6' ROTARY SYSTEM	\$ 173.95
UFL-R007	7' ROTARY SYSTEM	\$ 173.95
UFL-R008	8' ROTARY SYSTEM	\$ 173.95
UFL-R009	9' ROTARY SYSTEM	\$ 173.95
UFL-R010	10' ROTARY SYSTEM	\$ 173.95
UFL-R011	11' ROTARY SYSTEM	\$ 173.95
UFL-R012	12' ROTARY SYSTEM	\$ 173.95
UFL-R013	13' ROTARY SYSTEM	\$ 173.95
UFL-R014	14' ROTARY SYSTEM	\$ 173.95
UFL-R015	15' ROTARY SYSTEM	\$ 173.95
UFL-R016	16' ROTARY SYSTEM	\$ 173.95
UFL-R017	17' ROTARY SYSTEM	\$ 173.95
UFL-R018	18' ROTARY SYSTEM	\$ 173.95
UFL-R019	19' ROTARY SYSTEM	\$ 173.95
UFL-R020	20' ROTARY SYSTEM	\$ 173.95
UFL-R021	21' ROTARY SYSTEM	\$ 199.95
UFL-R022	22' ROTARY SYSTEM	\$ 229.95
UFL-R023	23' ROTARY SYSTEM	\$ 229.95



## UFLEX STANDARD ROTARY HELM

All stainless steel cable output ends as per ABYC safety standards. Corrosion resistant materials. Particularly suitable where clearance is limited. Optional 90° or 20° installation with or without friction kit. Lock-to-lock steering wheel turns: approx. 3.8 Stroke: 9". Maximum allowable steering wheel diameter: 20". Minimum steering cable bend radius: 7.9".

UFL-T71FC	ROTARY STEERING HELM	\$ 76.95
UFL-X34	90 DEG. MOUNTING BEZEL COMPLETE KIT	\$ 21.25
UFL-X35	20 DEG. MOUNTING BEZEL COMPLETE KIT	\$ 21.25

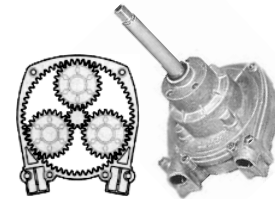

## UFLEX M66 ROTARY CABLES

UFL-M66-08	8' ROTARY CABLE	\$ 121.95
UFL-M66-09	9' ROTARY CABLE	\$ 121.95
UFL-M66-10	10' ROTARY CABLE	\$ 121.95
UFL-M66-11	11' ROTARY CABLE	\$ 121.95
UFL-M66-12	12' ROTARY CABLE	\$ 121.95
UFL-M66-13	13' ROTARY CABLE	\$ 121.95
UFL-M66-14	14' ROTARY CABLE	\$ 121.95
UFL-M66-15	15' ROTARY CABLE	\$ 121.95
UFL-M66-16	16' ROTARY CABLE	\$ 121.95
UFL-M66-17	17' ROTARY CABLE	\$ 121.95
UFL-M66-18	18' ROTARY CABLE	\$ 121.95
UFL-M66-19	19' ROTARY CABLE	\$ 121.95
UFL-M66-20	20' ROTARY CABLE	\$ 121.95

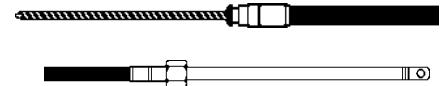

## UFLEX RACKTECH RACK STEERING SYSTEM

A convenient kit form, especially suitable as replacement steering, that includes helm, bezel and cable. The cable is available in 1-ft increments from 7 to 20 feet. The wheel is not included.



### RACK STEERING SYSTEM

- 1 #M86 - PREASSEMBLED HELM WITH STEERING CABLE
- 1 #G86 - SHAFT ASSEMBLY
- 1 #X34 - 90° BEZEL

UFL-RACK07	7' RACK SYSTEM	\$ 173.95
UFL-RACK08	8' RACK SYSTEM	\$ 173.95
UFL-RACK09	9' RACK SYSTEM	\$ 173.95
UFL-RACK10	10' RACK SYSTEM	\$ 173.95
UFL-RACK11	11' RACK SYSTEM	\$ 173.95
UFL-RACK12	12' RACK SYSTEM	\$ 173.95
UFL-RACK13	13' RACK SYSTEM	\$ 173.95
UFL-RACK14	14' RACK SYSTEM	\$ 173.95
UFL-RACK15	15' RACK SYSTEM	\$ 173.95
UFL-RACK16	16' RACK SYSTEM	\$ 173.95
UFL-RACK17	17' RACK SYSTEM	\$ 173.95
UFL-RACK18	18' RACK SYSTEM	\$ 173.95
UFL-RACK19	19' RACK SYSTEM	\$ 173.95
UFL-RACK20	20' RACK SYSTEM	\$ 173.95

## UFLEX G86 SINGLE RACK HELM



Stainless steel cable output ends. Corrosion resistant materials. Optional 90° or 20° installation. Standard 3/4" tapered shaft. Lock-to-lock steering wheel turns: 3.5. Stroke: 8.2". Maximum allowable steering wheel dia: 16.5" Minimum steering cable bend radius: 7.9". Available in package with RACKTECH complete system.

UFL-G86	SINGLE RACK HELM	\$ 71.25
UFL-X34	90 DEG. MOUNTING BEZEL COMPLETE KIT	\$ 21.25
UFL-X35	20 DEG. MOUNTING BEZEL COMPLETE KIT	\$ 21.25

## UFLEX M86 REPLACEMENT RACK CABLES

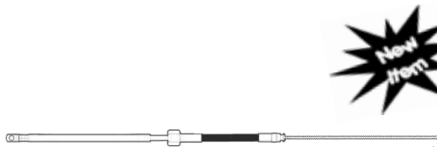

UFL-M86X13	13' RACK	\$ 114.95
UFL-M86X14	14' RACK	\$ 114.95
UFL-M86X15	15' RACK	\$ 114.95
UFL-M86X16	16' RACK	\$ 114.95
UFL-M86X17	17' RACK	\$ 114.95
UFL-M86X18	18' RACK	\$ 114.95
UFL-M86X19	19' RACK	\$ 114.95
UFL-M86X20	20' RACK	\$ 114.95

## UFLEX STEERING CABLE ADAPTERS

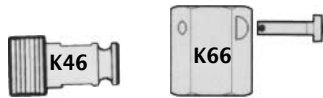

K46 = Adapts M47 cable to D290 helm and UFLEX FC helms  
K66 = Adapts M66 cable to threaded helms

UFL-K46	K46 35679 L CABLE ADAPTOR	\$ 19.51
UFL-K66	K66 38432 Q CABLE ADAPTOR	\$ 12.47

## TODD CENTER STEERING CONSOLE



Todd Steering Consoles are all constructed of rugged, UV stabilized, white polyethylene which will stand up to all weather conditions with a minimum of maintenance. Each steering console features a dry storage compartment. Steering systems are not supplied with the consoles. Each console can be easily installed on your boat. Available in white only. A small, lightweight steering console that will fit on most inflatable boats and includes a grabrail. Dimensions: 16 3/4"W, 11 1/2"D, 32 3/4"H Cutout: 8 1/2"W, 11 1/2"H.

TOD95-3005	STEERING CONSOLE	\$ 299.00	F
------------	------------------	-----------	---

selecting replacement mechanical steering

## *How to Measure Steering Cables* *"Measure Twice. Order Once."*

### *New Installation:*

**Measure cable routing path from wheel center line to engine connection, as follows:**

- A = Center line of wheel to gunwale (or deck, if routed downward),
- B = Dash to transom,
- C = Gunwale to centerline of cable connection at centered tiller.

TYPICAL SINGLE STATION ROUTING

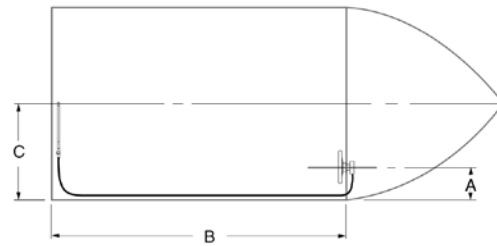

### **For Cable Installations through the Engine Tilt Tube:**

Add A, B & C + 6", then round **up** to the next foot. Order that length cable.

### **For Cables Mounted to Transom, Splashwell or Stringer:**

Add A, B & C, then subtract 6" and round **up** to the next foot. Order that length cable.

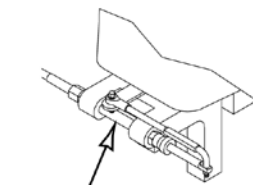

**CABLE THROUGH ENGINE TILT TUBE**

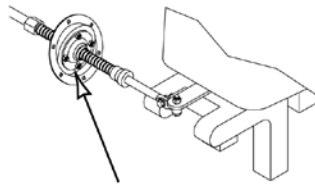

**SPLASHWELL CABLE MOUNT**

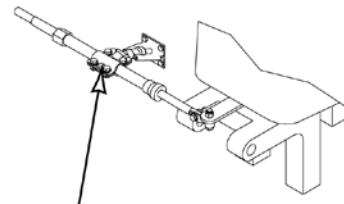

**TRANSOM CABLE MOUNT (similar to stringer type)**

### *Replacement of Existing Cable:*

If possible, find the part number stamped on the plastic jacket of the old cable. If you removed the old cable, measure for the replacement cable as follows:



**For Rotary Steering Cable Replacement, Measure Existing Cable as follows:** Measure plastic cable jacket ("Y" dimension, shown in above drawing) in inches, add 18", and round **up** to next foot. Order that length cable.

**For Rack Steering Cable Replacement, Measure Existing Cable as follows:** Measure plastic cable jacket ("Y" dimension shown in above drawing) in inches, add 30", and round **up** to next foot. Order that length cable.

**For JBS Jet Boat Cable Replacement, Measure Existing Cable as follows:** Measure cable from tip to tip. (Round **up** to next foot if needed for whole foot.) Order that length cable.

